

1		2		3		4		5		6	
Document No.	QR4-700-T-003	REV.	A/0	REV.	DESCRIPTION	REVISOR	DATE	APPROVED			
		0		LJ.Zhang	01.21.2015	David					

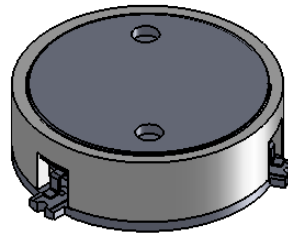

SPECIFICATIONS	
Part's Number	JCM0860T0885S10R
Frequency(GHz)	0.860~0.885
Direction	CW
Insertion Loss(dB)MAX	0.28
Isolation(dB)MIN	23.0
Return Loss(dB)MIN	21.0
3rd IMD(dBc)MAX	
Power FWD/REV/PK(Watt)	100/100/500
Operating Temperature(°C)	-30~+75
Storage Temperature(°C)	-
2nd/3rd Harmonic(dBc)	-
Termination/Attenuator(Watt/dB)	-
Tab(W×LG×THK)(mm[Inch])	-
Additional Notes	-

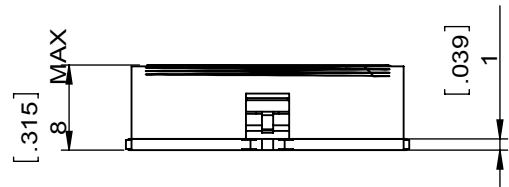
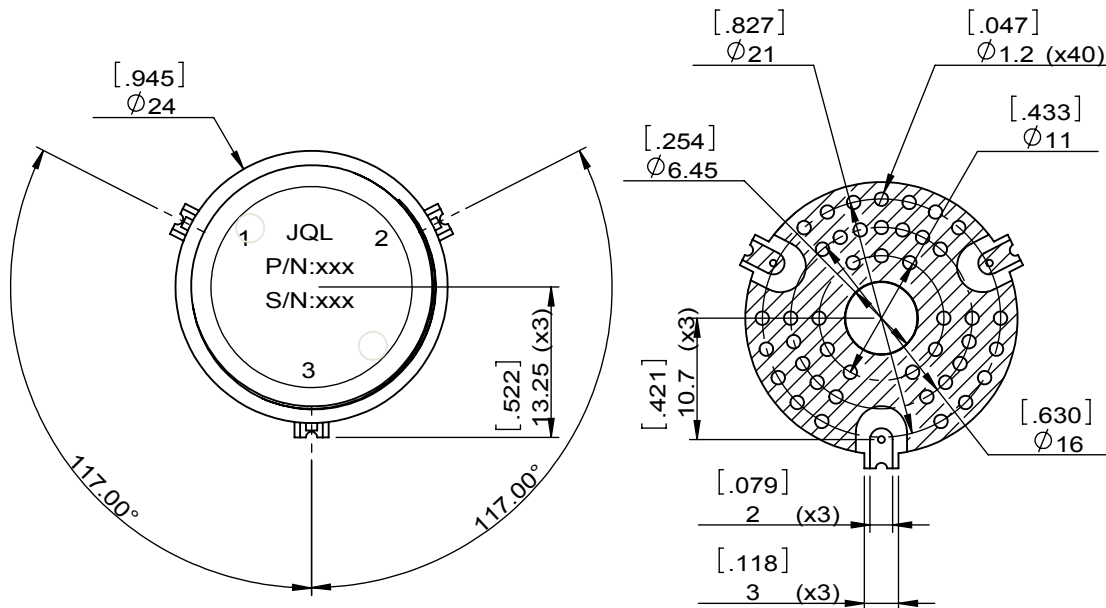

JQL JQL Electronic Inc				
MATERIAL: STEEL		DWG NO: JCM0860T0885S10R		
SURFACE TREATMENT: NICKEL PLATED		DWG BY:	LJ.Zhang	01.21.2015
DESCRIPTION: SMT CIRCULATOR		CHK'D BY:		SACLE
		APPV'D BY:		3:2
		Unit: mm[inch]	Tolerance: Liner: ±0.25 Anguar: ±0.5°	The First: A4



This document is the property of JQL Electronic Inc. It cannot be copied, duplicated, used for manufacturing purposes or communicated to third party as a whole or partly, without the written consent of JQL Electronic Inc.

WEIGHT:

SHEET 1 OF 1