

1		2		3		4		5		6	
Document No.	QR4-700-T-003	REV.	A/0	REV.	DESCRIPTION	REVISOR	DATE	APPROVED			
		0		ZC.Wu	05.04.2015	David					

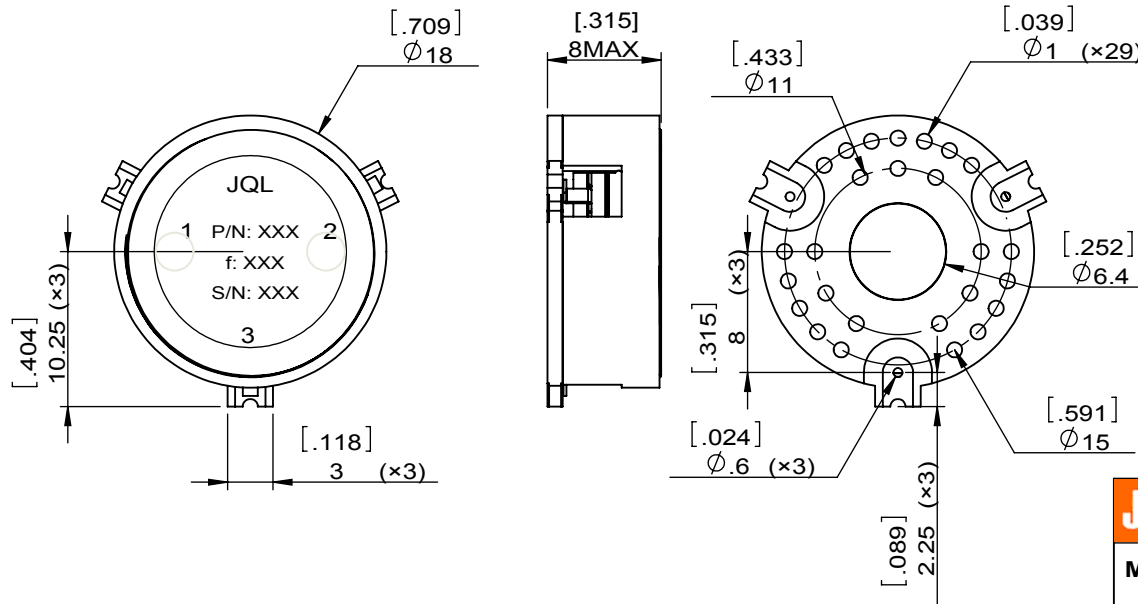

SPECIFICATIONS	
Part's Number	JCM3300T3800S6R
Frequency(GHz)	3.300~3.800
Direction	CW
Insertion Loss(dB)MAX	0.35
Isolation(dB)MIN	20.0
Return Loss(dB)MIN	19.0
3rd IMD(dBc)MAX	-
Power FWD/REV/PK(Watt)	60/60/-
Operating Temperature($^{\circ}$ C)	-40~+85
Storage Temperature($^{\circ}$ C)	-
2nd/3rd Harmonic(dBc)	-
Termination/Attenuator(Watt/dB)	-
Tab(W \times LG \times THK)(mm[Inch])	-
Additional Notes	-

JQL JQL Electronic Inc				
MATERIAL: STEEL		DWG NO: JCM3300T3800S6R		
SURFACE TREATMENT: NICKEL PLATING		DWG BY:	ZC.Wu	05.04.2015
DESCRIPTION: SMT CIRCULATOR		CHK'D BY:		SCALE
		APPV'D BY:		1:1
		Unit: mm[inch]	Tolerance: Liner: ± 0.25 Anguar: $\pm 0.5^{\circ}$	The First:
				A4

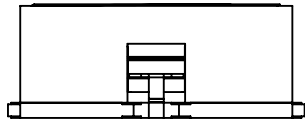
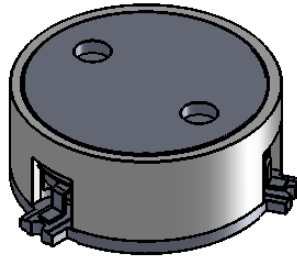

This document is the property of JQL Electronic Inc. It cannot be copied, duplicated, used for manufacturing purposes or communicated to third party as a whole or partly, without the written consent of JQL Electronic Inc.