

1		2		3		4		5		6	
Document No.	QR4-700-T-003	REV.	A/0	REV.	DESCRIPTION	REVISOR	DATE	APPROVED			
		0		ZC.Wu	10.10.2014	David					

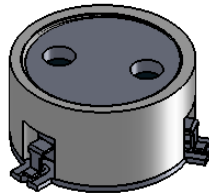

SPECIFICATIONS	
Part's Number	JCM4800T6500VM2R
Frequency(GHz)	4.800~6.500
Direction	CW
Insertion Loss(dB)MAX	0.50
Isolation(dB)MIN	18.0
Return Loss(dB)MIN	18.0
3rd IMD(dBc)MAX	-
Power FWD/REV/PK(Watt)	5/5/
Operating Temperature(°C)	-40~+85
Storage Temperature(°C)	
2nd/3rd Harmonic(dBc)	-
Termination/Attenuator(Watt/dB)	-
Tab(W×LG×THK)(mm[Inch])	-
Additional Notes	-

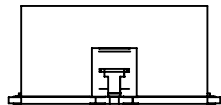
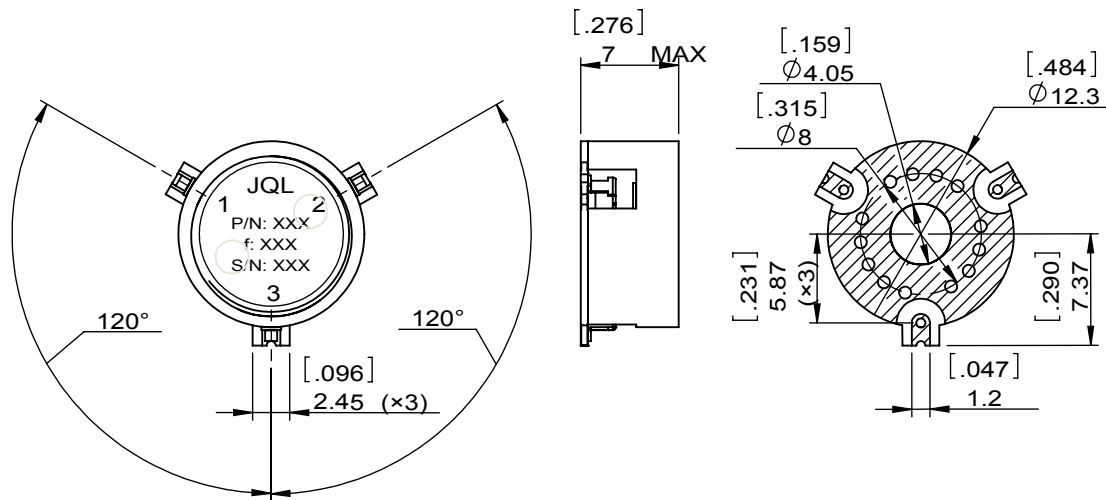

<b>JQL</b> JQL Electronic Inc				
<b>MATERIAL:</b> STEEL		<b>DWG NO:</b> JCM4800T6500VM2R		
<b>SURFACE TREATMENT:</b> SILVER PLATING		DWG BY:	ZC.Wu	10.10.2014
<b>DESCRIPTION:</b> SMT CIRCULATOR		CHK'D BY:		SCALE
		APPV'D BY:		2:1
		Unit: mm[inch]	Tolerance: Liner: ±0.25 Anguar: ±0.5°	The First: 
				A4



This document is the property of JQL Electronic Inc. It cannot be copied, duplicated, used for manufacturing purposes or communicated to third party as a whole or partly, without the written consent of JQL Electronic Inc.