

1		2		3		4		5		6	
Document No.	QR4-700-T-003	REV.	A/0	REV.	DESCRIPTION	REVISOR	DATE	APPROVED			
		0		ZC.Wu	01.08.2015	David					

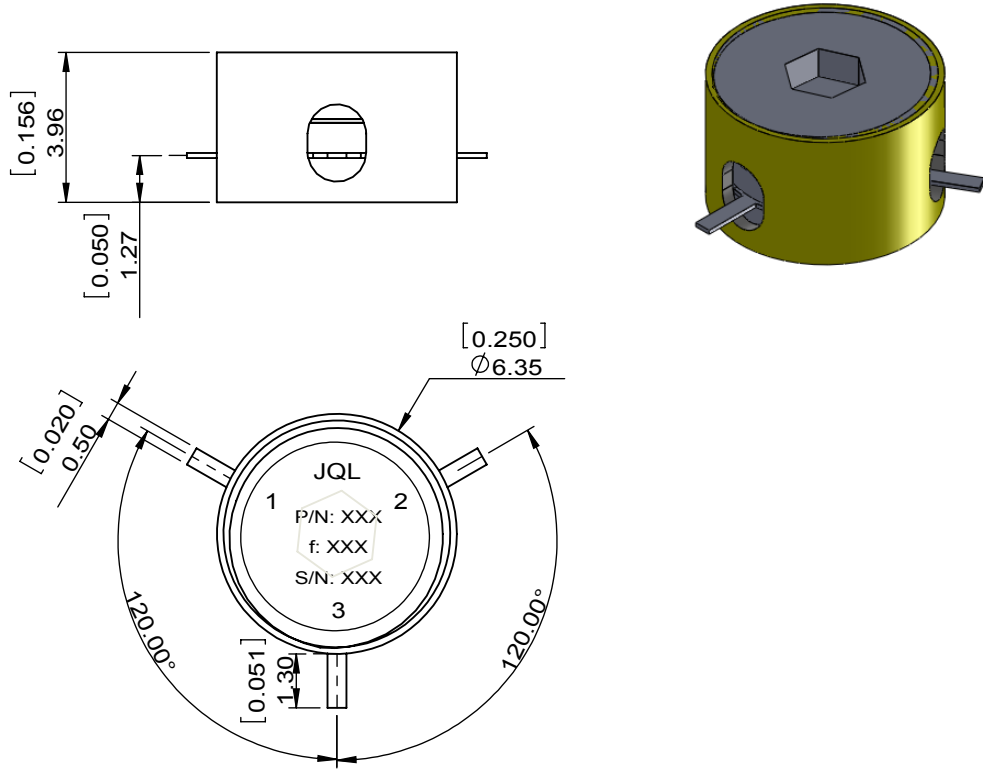

SPECIFICATIONS	
Part's Number	JCM9900T10K6G0
Frequency(GHz)	9.900~10.60
Direction	CW
Insertion Loss(dB)MAX	0.5
Isolation(dB)MIN	20.0
Return Loss(dB)MIN	20.0
3rd IMD(dBc)MAX	
Power FWD/REV/PK(Watt)	5/5/-
Operating Temperature(°C)	-40~+85
Storage Temperature(°C)	-
2nd/3rd Harmonic(dBc)	--
Termination/Attenuator(Watt/dB)	-
Tab(W×LG×THK)(mm[Inch])	-
Additional Notes	GOLD PLATED HOUSING;GOLD PLATED CIRCUIT-

JQL JQL Electronic Inc				
MATERIAL: VARIOUS		DWG NO: JCM9900T10K6G0		
SURFACE TREATMENT: GOLD PLATING		DWG BY:	ZC.Wu	01.08.2015
DESCRIPTION: SMT CIRCULATOR		CHK'D BY:		SCALE
		APPV'D BY:		5:1
		Unit: mm[inch]	Tolerance: Liner: ±0.25 Anguar: ±0.5°	The First:
				A4



This document is the property of JQL Electronic Inc. It cannot be copied, duplicated, used for manufacturing purposes or communicated to third party as a whole or partly, without the written consent of JQL Electronic Inc.