

1		2		3		4		5		6			
Document No.	QR4-700-T-003	REV.	A/0	REV.	0	DESCRIPTION		REVISOR	LJ.Zhang	DATE	01.22.2015	APPROVED	David

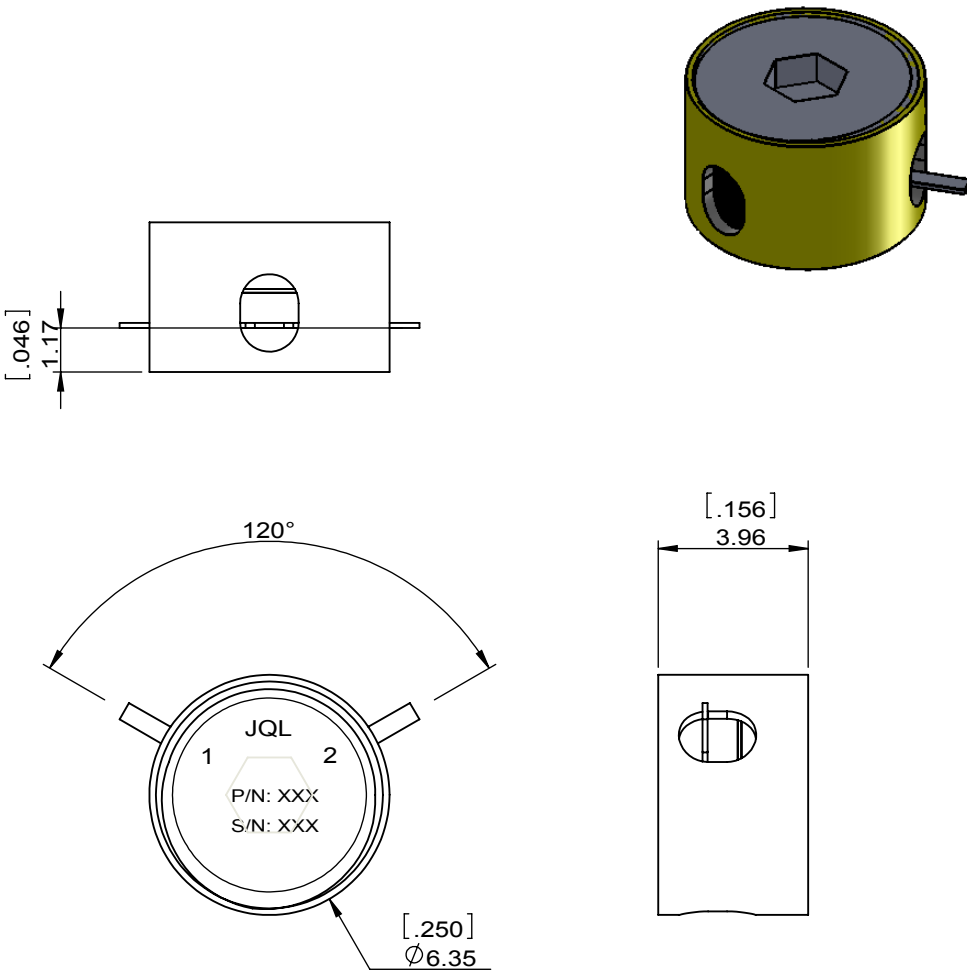

SPECIFICATIONS	
Part's Number	JIM9400T9800G0
Frequency(GHz)	9.400~9.800
Direction	CW
Insertion Loss(dB)MAX	0.50
Isolation(dB)MIN	20.0
Return Loss(dB)MIN	19.0
3rd IMD(dBc)MAX	-
Power FWD/REV/PK(Watt)	5/0.5/-
Operating Temperature(°C)	-40~+85
Storage Temperature(°C)	-
2nd/3rd Harmonic(dBc)	-
Termination/Attenuator(Watt/dB)	-
Tab(W×LG×THK)(mm[Inch])	0.5[.02]×1.3[.05]×0.12[.005]
Additional Notes	GOLD PLTED HOUSING;GOLD PLTED CIRCUIT

JQL JQL Electronic Inc				
MATERIAL: STEEL		DWG NO: JIM9400T9800G0		
SURFACE TREATMENT: GOLD PLATED		DWG BY:	LJ.Zhang	01.22.2015
DESCRIPTION: SMT-ISOLATOR		CHK'D BY:		SACLE
		APPV'D BY:		5:1
Unit: mm[inch]	Tolerance: Liner: ±0.25 Anguar: ±0.5°	The First:		A4

RoHS COMPLIANCE This document is the property of JQL Electronic Inc. It cannot be copied, duplicated, used for manufacturing purposes or communicated to third party as a whole or partly, without the written consent of JQL Electronic Inc.