

Stock Number

[1.25]
31.75

REV.	DESCRIPTION	REVISOR	DATE	APPROVE
0		MH	02.23.10	CH

P/N: JIWR42-9.5A-20K2T21K2
 FREQ: 20.20~21.20GHz

ISOLATION: 20dB MIN
 INS LOSS: 0.3dB MAX
 VSWR: 1.25:1 MAX
 PWR FWD/REV: 1W/1W
 TEMP: -30C~+75C
 WAVEGUIDE: UBR220

✓ [0.10]
 2- ϕ 2.65, THRU
 ϕ 4.88- ϕ 5.13 X 100°
 BOTH SIDES

[0.12]
 4- ϕ 3, THRU



This document is the property of JQL Electronic Inc.
 It cannot be copied, duplicated, used for manufacturing purposes
 or communicated to third party as a whole or partly,
 without the written consent of JQL Electronic Inc.

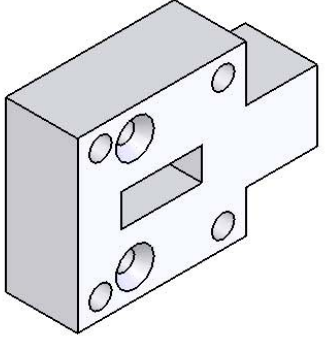

JQL JQL Electronic Inc

500 Lake Cook Road, Suite 350 Tel : 1(888)236-9828
 Deerfield, IL 60015, USA Fax: 1(630)823-2902

MATERIAL:
 SURFACE TREATMENT:
 DESCRIPTION:
WAVEGUIDE ISO

DWG NO.		SCALE:	
JIWR42-9.5A-20K2T21K2		1:1	
DWG BY:	NAME	DATE	Type Of Projection
CHK'D BY:	MH	02.23.10	
APPVD BY:	SY	02.23.10	
Unit: mm	TOLERANCE:	Type Of Projection	
	Liner: \pm 0.1mm		
	Angular: \pm 0.5°		

WEIGHT:

SHEET 1 OF 1