

REV.	DESCRIPTION	REVISOR	DATE	APPROVE

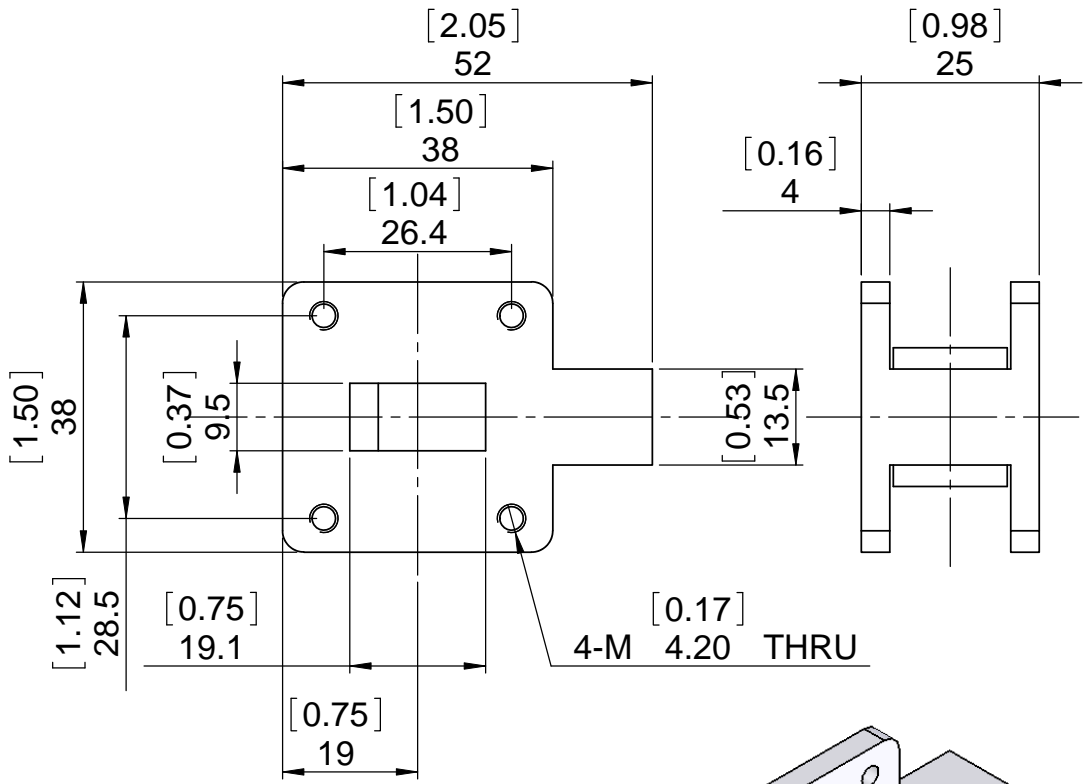

SPECIFICATIONS

P/N: JIWR75-25-10K5T11K5
 FREQ: 10.50~11.50GHz
 ISOLATION: 25dB MIN
 INS LOSS: 0.25dB MAX
 VSWR: 1.20:1 MAX
 PWR FWD/REV 10W/5W
 WAVEGUIDE: WR75
 TEMP: -30~+70C

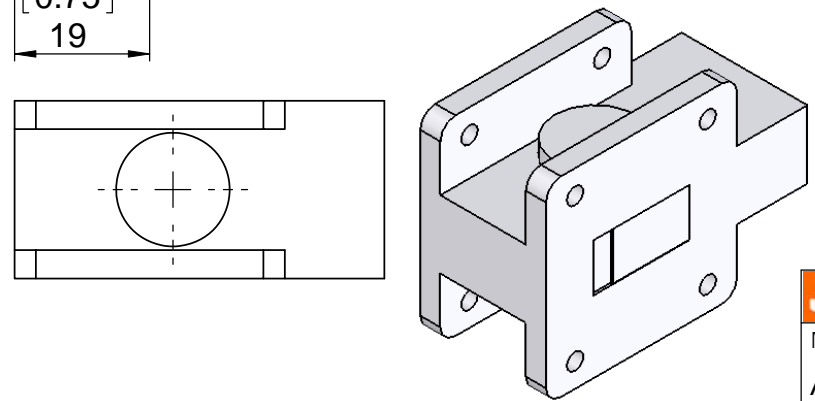

This document is the property of JQL Electronic Inc. It cannot be copied, duplicated, used for manufacturing purposes or communicated to third party as a whole or partly, without the written consent of JQL Electronic Inc.

JQL JQL Electronic Inc		500 Lake Cook Road, Suite 350 Deerfield, IL 60015, USA		Tel : 1(888)236-9828 Fax: 1(630)823-2902	
MATERIAL: ALUMINUM		DWG NO. JIWR75-25-10K5T11K5			
SURFACE TREATMENT:					
DESCRIPTION: WAVEGUIDE		NAME		DATE	
		SIGNATURE		REV:	
		DWG BY: SY		01.13.09	
		CHK'D BY: GC		01.13.09	
		APPV'D BY: JZ		01.13.09	
		TOLERANCE		Q.A	
		Liner: ±0.1mm		A4	
		Angular: ±0.5°			