

1		2		3		4		5		6	
Document No.	QR4-700-T-003	REV.	A/0	REV.	DESCRIPTION	REVISOR	DATE	APPROVED			
		0				LJ.Zhang	01.15.2014	David			

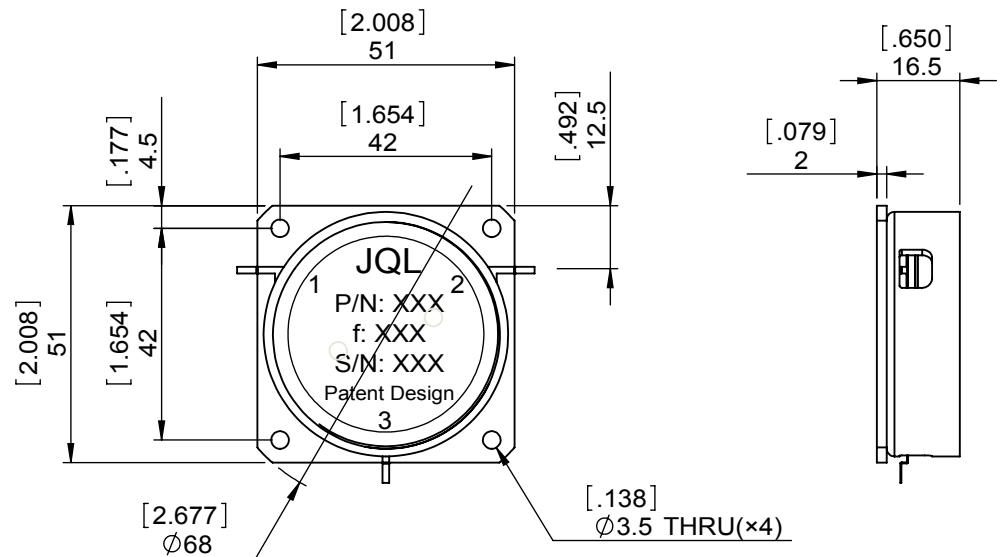

SPECIFICATIONS	
Part's Number	JCD0370T0440UM15
Frequency(GHz)	0.370~0.440
Direction	CW
Insertion Loss(dB)MAX	0.40
Isolation(dB)MIN	20.0
Return Loss(dB)MIN	20.0
3rd IMD(dBc)MAX	-
Power FWD/REV/PK(Watt)	150/150/-
Operating Temperature(°C)	-20~+60
Storage Temperature(°C)	-
2nd/3rd Harmonic(dBc)	-
Termination/Attenuator(Watt/dB)	-
Tab(W×LG×THK)(mm[Inch])	1.27[.05]×4[.157]×0.2[.008]
Additional Notes	-

NOTES:
 1. STANDARD INPUT/OUTPUT 50OHM IMPEDANCE
 2. S-PARAMETERS TO BE MEASURED BY CONNECTING PORT 1 AND PORT 2 TO VNA, PORT 3 TO LOAD
 3. LOAD RETURN LOSS IS 30dB OR HIGHER WHEN TUNING

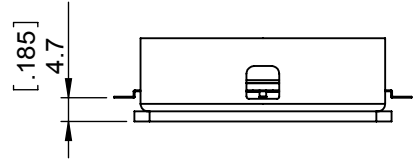
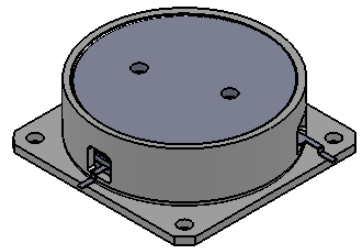

This document is the property of JQL Electronic Inc. It cannot be copied, duplicated, used for manufacturing purposes or communicated to third party as a whole or partly, without the written consent of JQL Electronic Inc.

JQL **JQL Electronic Inc** 500 Lake Cook Road, Suite 350 Deerfield, IL 60015, USA Tel: 1(888)236-9828 Fax: 1(888)823-2902

MATERIAL: STEEL	DWG NO: JCD0370T0440UM20			
SURFACE TREATMENT: NICKEL PLATING	DWG BY:	LJ.Zhang	01.15.2014	SACLE
	CHK'D BY:			
DESCRIPTION: DROP-IN CIRCULATOR	APPV'D BY:			2:3
	Unit: mm[inch]	Tolerance: Liner: ±0.25 Anguar: ±0.5°	The First:	A4