

1		2		3		4		5		6	
Document No.	QR4-700-T-003	REV.	A/0	REV.	DESCRIPTION	REVISOR	DATE	APPROVED			
		0		ZC.Wu	09.27.2014	David					

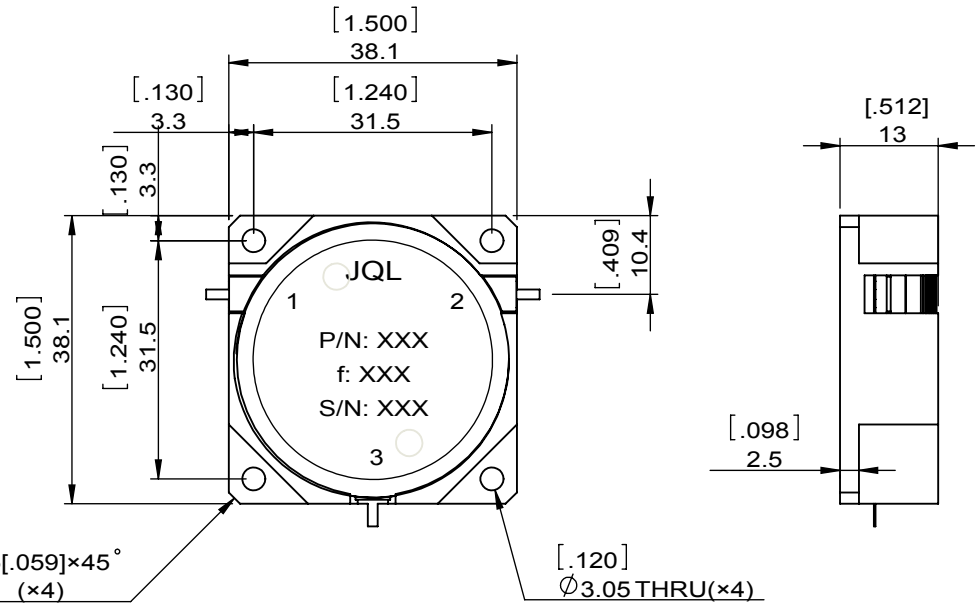

SPECIFICATIONS	
Part's Number	JCD0450T0470KM15
Frequency(GHz)	0.450~0.470
Direction	CW
Insertion Loss(dB)MAX	0.3
Isolation(dB)MIN	23
Return Loss(dB)MIN	20.0
3rd IMD(dBc)MAX	-
Power FWD/REV/PK(Watt)	150/150/-
Operating Temperature(°C)	-20~+80
Storage Temperature(°C)	
2nd/3rd Harmonic(dBc)	-
Termination/Attenuator(Watt/dB)	-
Tab(W×LG×THK)(mm[Inch])	1.3[.05]×3.0[.012]×0.2[.008]
Additional Notes	-

<b>JQL</b> JQL Electronic Inc				
<b>MATERIAL:</b> STEEL		<b>DWG NO:</b> JCD0450T0470KM15		
<b>SURFACE TREATMENT:</b> NICKEL PLATING		DWG BY:	ZC.Wu	09.27.2014
<b>DESCRIPTION:</b> DROP-IN CIRCULATOR		CHK'D BY:		SCALE
		APPV'D BY:		1:1
		Unit: mm[inch]	Tolerance: Liner: ±0.25 Anguar: ±0.5°	The First: 
				A4

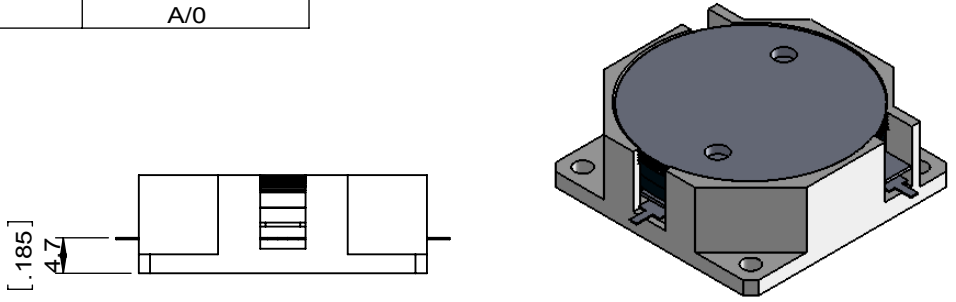

This document is the property of JQL Electronic Inc. It cannot be copied, duplicated, used for manufacturing purposes or communicated to third party as a whole or partly, without the written consent of JQL Electronic Inc.