

1		2		3		4		5		6	
Document No.	QR4-700-T-003					REV.	DESCRIPTION	REVISOR	DATE	APPROVED	
REV.	A/0					0		LJ.Zhang	02.27.2014	David	

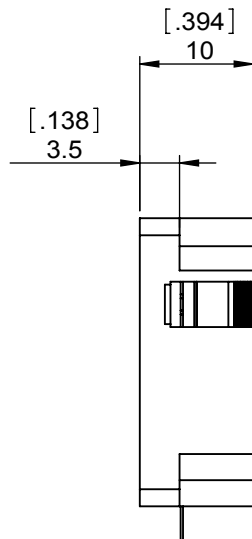

SPECIFICATIONS	
Part's Number	JCD0793T0869M10
Frequency(GHz)	0.793~0.869
Direction	CW
Insertion Loss(dB)MAX	0.3
Isolation(dB)MIN	22.0
Return Loss(dB)MIN	22.0
3rd IMD(dBc)MAX	
Power FWD/REV/PK(Watt)	150/150/-
Operating Temperature(°C)	-30~+85
Storage Temperature(°C)	-
2nd/3rd Harmonic(dBc)	-
Termination/Attenuator(Watt/dB)	-
Tab(W×LG×THK)(mm[Inch])	1.0[0.039]×2.5[0.10]×0.2[0.008]
Additional Notes	-

NOTES:
 1.STANDARD INPUT/OUTPUT 50OHM IMPEDANCE
 2.BEO FREE,LEAD FREE,NO Nd MATERIAL
 3.RoHS COMPLIANT
 4.S-PARAMETERS TO BE MEASURED BY CONECTING PORT 1 AND PORT 2 TO VNA, PORT 3 TO LOAD
 5.LOAD RETURN LOSS IS 30dB OR HIGHER WHEN TUNING

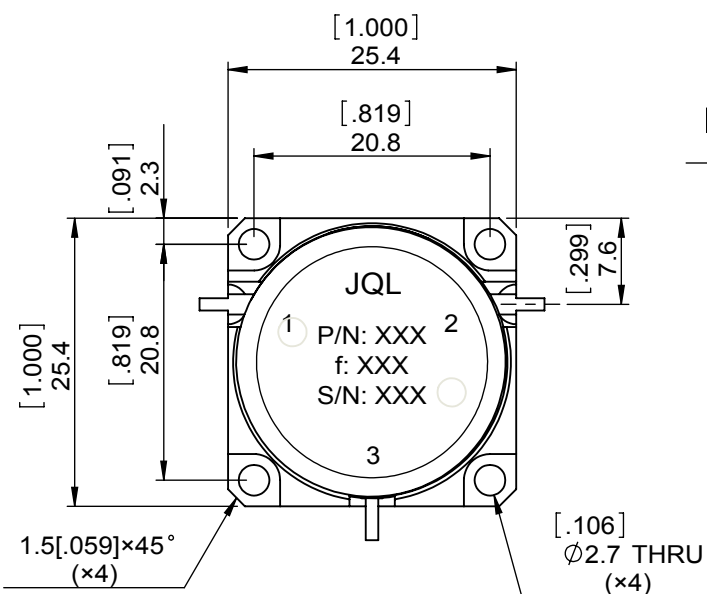
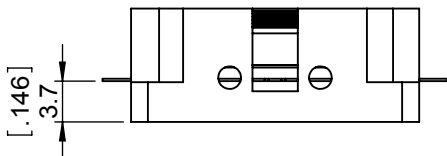
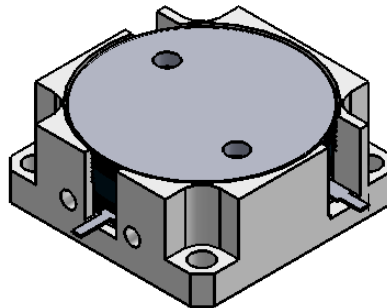

This document is the property of JQL Electronic Inc. It cannot be copied, duplicated, used for manufacturing purposes or communicated to third party as a whole or partly, without the written consent of JQL Electronic Inc.

JQL JQL Electronic Inc		500 Lake Cook Road, Suite 350 Deerfield, IL 60015, USA		Tel: 1(888)236-9828 Fax: 1(888)823-2902	
MATERIAL: STEEL	DWG NO: JCD0793T0869M10				
SURFACE TREATMENT: NICKEL PLATING	DWG BY:	LJ.Zhang	02.27.2014	SACLE	
	CHK'D BY:				
DESCRIPTION: DROP-IN CIRCULATOR	APPV'D BY:			3:2	
	Unit: mm[inch]	Tolerance: Liner: ±0.25 Anguar: ±0.5°	The First:		A4