

1		2		3		4		5		6	
Document No.	QR4-700-T-003	REV.	A/0	REV.	DESCRIPTION	REVISOR	DATE	APPROVED			
		0		LJ.Zhang	02.27.2014	David					

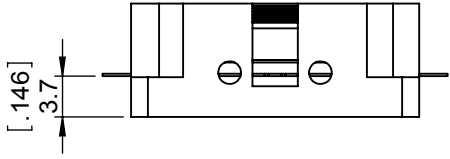

SPECIFICATIONS	
Part's Number	JCD0930T0960M30
Frequency(GHz)	0.930~0.960
Direction	CW
Insertion Loss(dB)MAX	0.25
Isolation(dB)MIN	21.0
Return Loss(dB)MIN	21.0
3rd IMD(dBc)MAX	
Power FWD/REV/PK(Watt)	300/300/-
Operating Temperature(°C)	-40~+80
Storage Temperature(°C)	-
2nd/3rd Harmonic(dBc)	-
Termination/Attenuator(Watt/dB)	-
Tab(W×LG×THK)(mm[Inch])	1.0[0.039]×2.5[0.10]×0.2[0.008]
Additional Notes	-

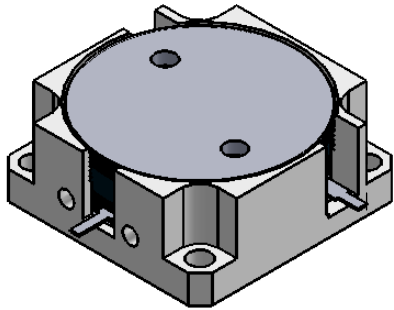
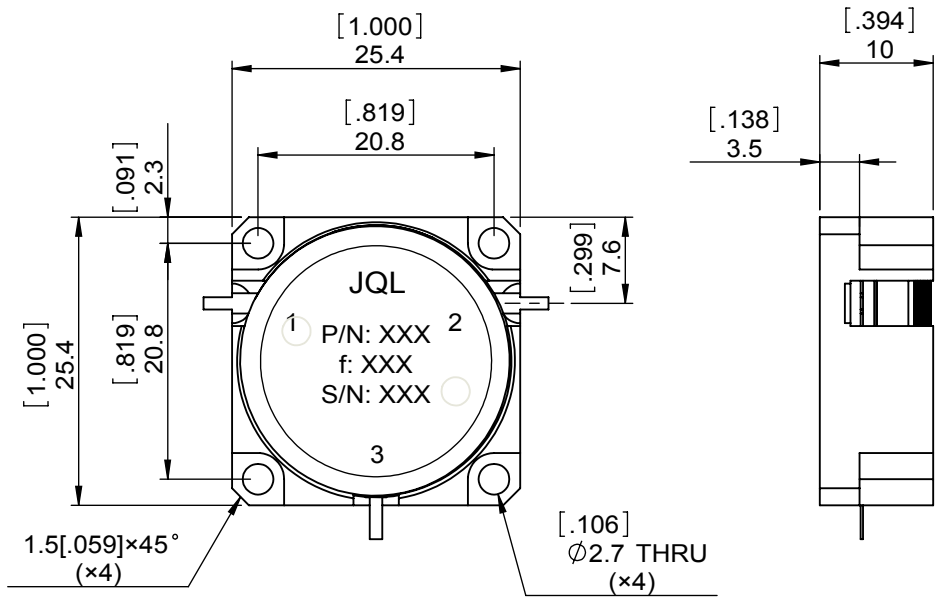

NOTES:
 1.STANDARD INPUT/OUTPUT 50OHM IMPEDANCE
 2.BEO FREE,LEAD FREE,NO Nd MATERIAL
 3.RoHS COMPLIANT
 4.S-PARAMETERS TO BE MEASURED BY CONECTING PORT 1 AND PORT 2 TO VNA, PORT 3 TO LOAD
 5.LOAD RETURN LOSS IS 30dB OR HIGHER WHEN TUNING



This document is the property of JQL Electronic Inc. It cannot be copied, duplicated, used for manufacturing purposes or communicated to third party as a whole or partly, without the written consent of JQL Electronic Inc.

JQL JQL Electronic Inc 500 Lake Cook Road, Suite 350 Deerfield, IL 60015, USA Tel: 1(888)236-9828 Fax: 1(888)823-2902

MATERIAL: STEEL	DWG NO: JCD0930T0960M30			
SURFACE TREATMENT: NICKEL PLATING	DWG BY:	LJ.Zhang	02.27.2014	SACLE
	CHK'D BY:			
DESCRIPTION: DROP-IN CIRCULATOR	APPV'D BY:			3:2
	Unit: mm[inch]	Tolerance: Liner: ±0.25 Anguar: ±0.5°	The First:	A4