

1		2		3		4		5		6	
Document No.	QR4-700-T-003	REV.	A/0	REV.	DESCRIPTION	REVISOR	DATE	APPROVED			
		0				ZC.Wu	10.09.2014	David			

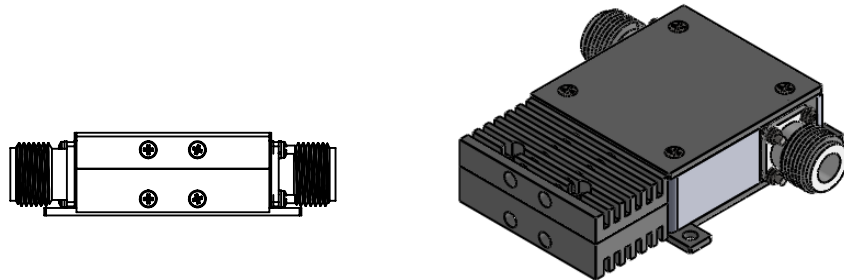

SPECIFICATIONS	
Part's Number	JIC0350T0385N6
Frequency(GHz)	0.350~0.385
Direction	CW
Insertion Loss(dB)MAX	0.30
Isolation(dB)MIN	25.0
Return Loss(dB)MIN	22.0
3rd IMD(dBc)MAX	-
Power FWD/REV/PK(Watt)	125/60/-
Operating Temperature(°C)	-20~+80
Storage Temperature(°C)	-
2nd/3rd Harmonic(dBc)	-
Termination/Attenuator(Watt/dB)	100
Tab(W×LG×THK)(mm[Inch])	-
Additional Notes	-

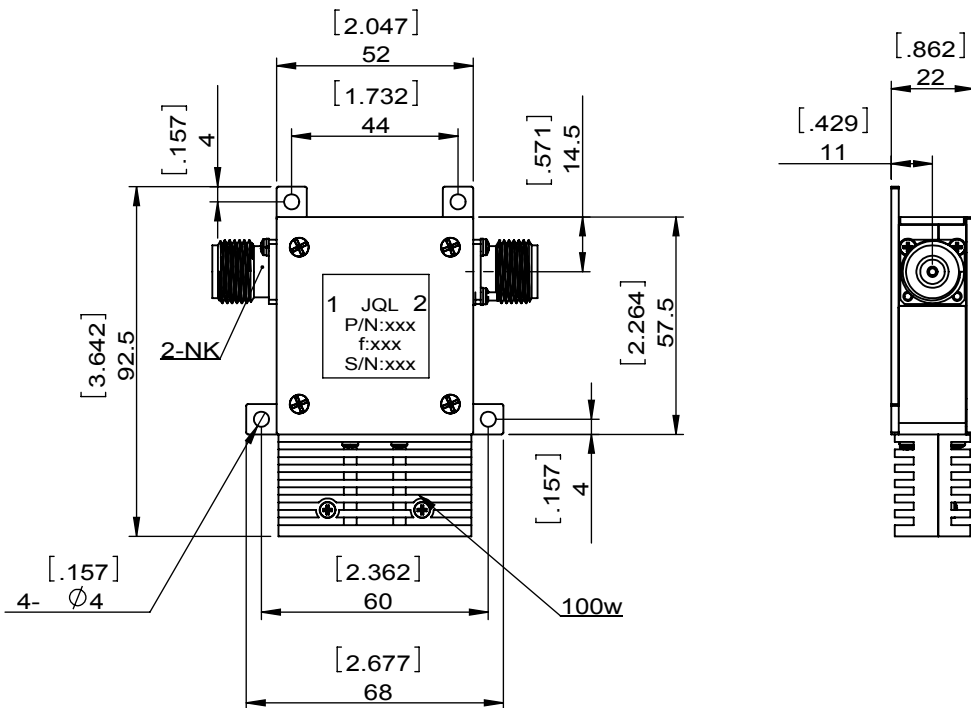

This document is the property of JQL Electronic Inc. It cannot be copied, duplicated, used for manufacturing purposes or communicated to third party as a whole or partly, without the written consent of JQL Electronic Inc.

JQL JQL Electronic Inc				
MATERIAL: STEEL		DWG NO: JIC0350T0385N6		
SURFACE TREATMENT: NICKEL PLATING		DWG BY:	ZC.Wu	10.09.2014
DESCRIPTION: COAXIAL ISOLATOR		CHK'D BY:		SCALE
		APPV'D BY:		1:2
Unit: mm[inch]	Tolerance: Liner: ±0.25 Anguar: ±0.5°	The First:		A4