

1		2		3		4		5		6	
Document No.	QR4-700-T-003	REV.	A/0	REV.	DESCRIPTION	REVISOR	DATE	APPROVED			
		0		ZC.Wu	03.02.2015	David					

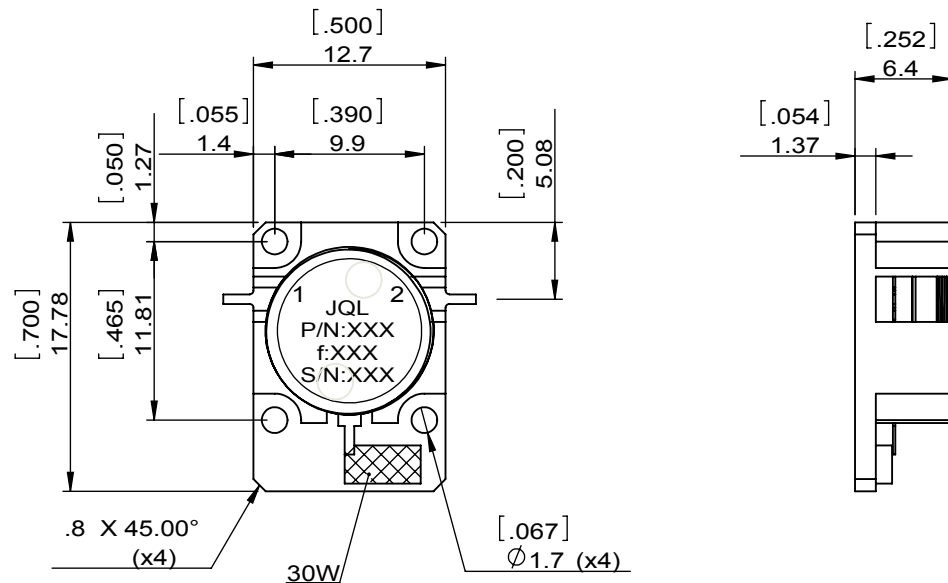

SPECIFICATIONS	
Part's Number	JID5150T5650VM2
Frequency(GHz)	5.150~5.650
Direction	CW
Insertion Loss(dB)MAX	0.40
Isolation(dB)MIN	20.0
Return Loss(dB)MIN	20.0
3rd IMD(dBc)MAX	-
Power FWD/REV/PK(Watt)	20/20/-
Operating Temperature(°C)	-40~+70
Storage Temperature(°C)	-
2nd/3rd Harmonic(dBc)	-
Termination/Attenuator(Watt/dB)	30/-
Tab(W×LG×THK)(mm[Inch])	0.635[.030]X1.9[.070]X0.15[.010]
Additional Notes	-

JQL JQL Electronic Inc				
MATERIAL: STEEL		DWG NO: JID5150T5650VM2		
SURFACE TREATMENT: NICKEL PLATING		DWG BY:	ZC.Wu	03.02.2015
DESCRIPTION: DROP-IN ISOLATOR		CHK'D BY:		SCALE
		APPV'D BY:		2:1
		Unit: mm[inch]	Tolerance: Liner: ±0.25 Anguar: ±0.5°	The First:
				A4

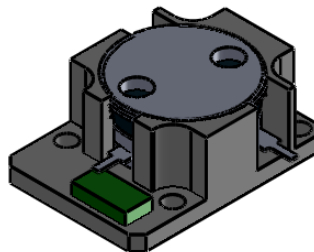
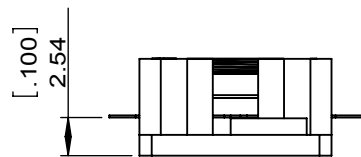

This document is the property of JQL Electronic Inc. It cannot be copied, duplicated, used for manufacturing purposes or communicated to third party as a whole or partly, without the written consent of JQL Electronic Inc.