

1		2		3		4		5		6	
Document No.	QR4-700-T-003	REV.	A/0	REV.	DESCRIPTION	REVISOR	DATE	APPROVED			
				0		LJ.Zhang	07.30.2015	David			

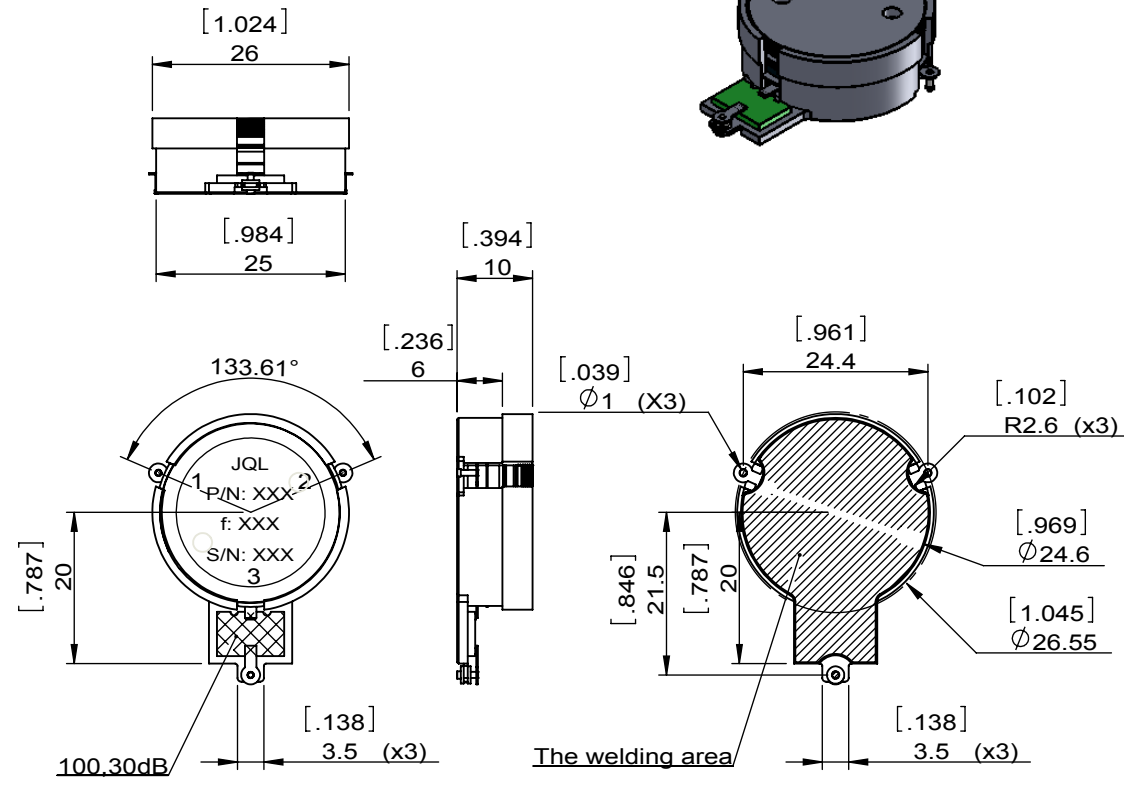

SPECIFICATIONS	
Part's Number	JIM0791T0821PN10A3
Frequency(GHz)	0.791~0.821
Direction	CW
Insertion Loss(dB)MAX	0.25
Isolation(dB)MIN	22.0
Return Loss(dB)MIN	22.0
3rd IMD(dBc)MAX	-70 2×50W 5MHz Spacing
Power FWD/REV/PK(Watt)	200/80/800
Operating Temperature(°C)	-40~+85
Storage Temperature(°C)	-
2nd/3rd Harmonic(dBc)	-
Termination/Attenuator(Watt/dB)	100/30
Tab(W×LG×THK)(mm[Inch])	-
Additional Notes	--

JQL JQL Electronic Inc				
MATERIAL: STEEL		DWG NO: JIM0791T0821PN10A3		
SURFACE TREATMENT: SILVER PLATING		DWG BY:	LJ.Zhang	07.30.2015
DESCRIPTION: SMT ISOLATOR		CHK'D BY:		SCALE
		APPV'D BY:		1:1
		Unit: mm[inch]	Tolerance: Liner: ±0.25 Anguar: ±0.5°	The First:
				A4

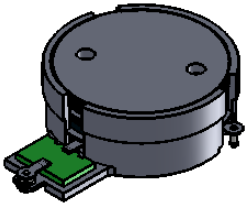

This document is the property of JQL Electronic Inc. It cannot be copied, duplicated, used for manufacturing purposes or communicated to third party as a whole or partly, without the written consent of JQL Electronic Inc.