

1		2		3		4		5		6	
Document No.	QR4-700-T-003	REV.	A/0	REV.	DESCRIPTION	REVISOR	DATE	APPROVED			
				0		YQ.XIE	11.06.2015	David			

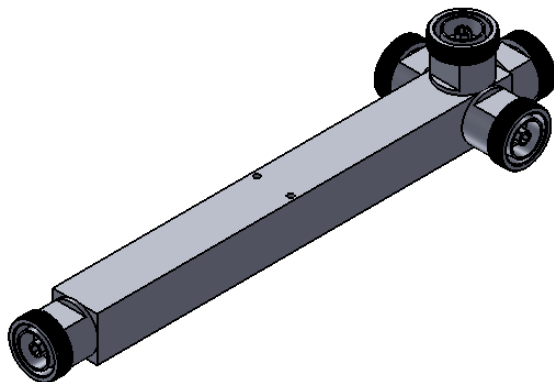

SPECIFICATIONS	
Part's Number	PSST0698T2700DF-4
Frequency(MHz)	0.698~2.700
Input	4-way
Split Loss(dB)	6.0
Insertion loss(dB)MAX	0.6
VSWR(dB)MAX	1.3
PIM(dBc)MAX	-150dBc@2×43dBm
Power FWD/REV/PK(Watt)	500/500/2000
Impedance(Ω)	50
Connector	7/16 N-female
Color	Black
Operating Temperature(°C)	-30~+65
Application	Indoor or Outdoor,IP65
Dimensions(mm)	279.9mm×71.7mm×25mm
Additional Notes	-

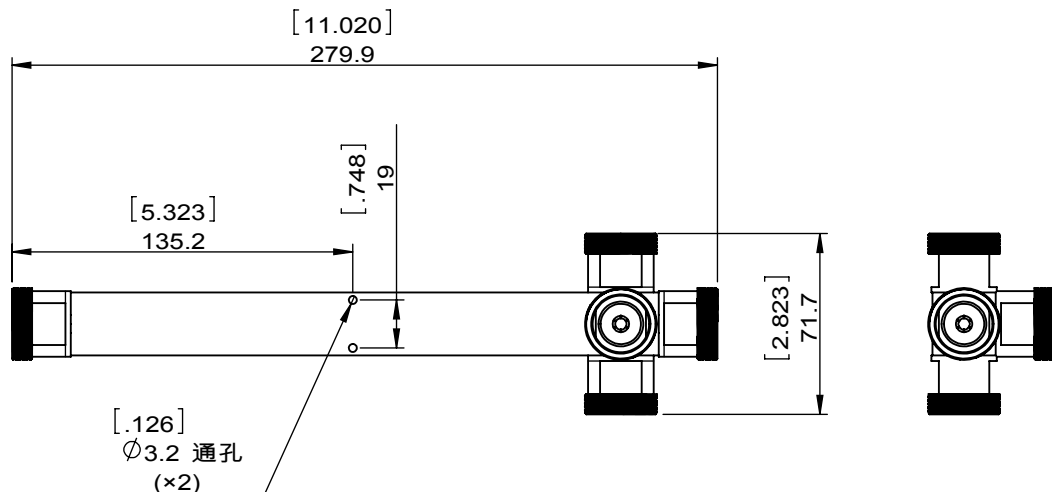

JQL JQL Electronic Inc				
MATERIAL:		DWG NO: PSST0698T2700DF-4		
SURFACE TREATMENT:		DWG BY:	YQ.XIE	11.06.2015
DESCRIPTION:		CHK'D BY:		SCALE
		APPV'D BY:		1:3
		Unit:	Tolerance:	The First:
		mm[inch]	Liner: ±0.25	
			Anguar: ±0.5°	A4



This document is the property of JQL Electronic Inc. It cannot be copied, duplicated, used for manufacturing purposes or communicated to third party as a whole or partly, without the written consent of JQL Electronic Inc.