

1		2		3		4		5		6	
Document No.	QR4-700-T-003	REV.	A/0	REV.	DESCRIPTION	REVISOR	DATE	APPROVED			
		0		ZC.Wu	07.25.2014	David					

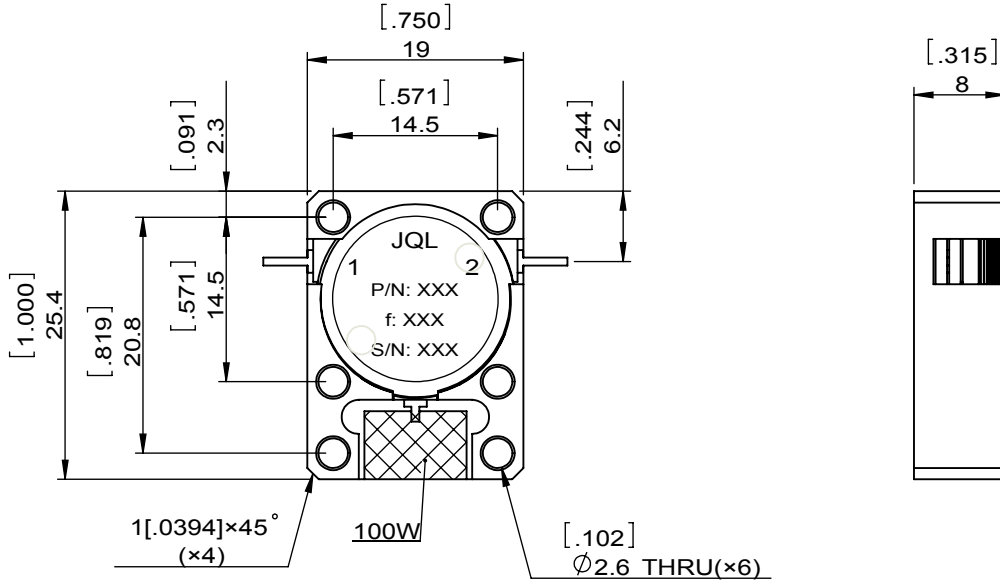

SPECIFICATIONS	
Part's Number	JID2400T2500SM10
Frequency(GHz)	2.400~2.500
Direction	CW
Insertion Loss(dB)MAX	0.30
Isolation(dB)MIN	22.0
Return Loss(dB)MIN	21.0
3rd IMD(dBc)MAX	
Power FWD/REV/PK(Watt)	100/100/-
Operating Temperature(°C)	-40~+85
Storage Temperature(°C)	-
2nd/3rd Harmonic(dBc)	
Termination/Attenuator(Watt/dB)	100/-
Tab(W×LG×THK)(mm[Inch])	0.7[.027]×3.81[.15]×0.2[.008]
Additional Notes	-

JQL JQL Electronic Inc				
MATERIAL: STEEL		DWG NO: JID2400T2500SM10		
SURFACE TREATMENT: NICKEL PLATING		DWG BY:	ZC.Wu	07.25.2014
DESCRIPTION: DROP-IN ISOLATOR		CHK'D BY:		SCALE
		APPV'D BY:		3:2
Unit: mm[inch]	Tolerance: Liner: ±0.25 Anguar: ±0.5°	The First:		A4

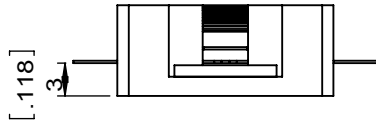
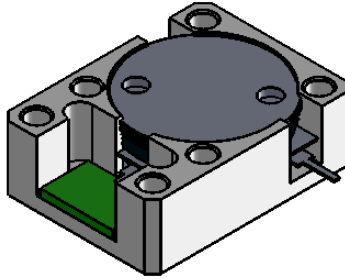

This document is the property of JQL Electronic Inc. It cannot be copied, duplicated, used for manufacturing purposes or communicated to third party as a whole or partly, without the written consent of JQL Electronic Inc.