

1		2		3		4		5		6	
Document No.	QR4-700-T-003	REV.	A/0	REV.	DESCRIPTION	REVISOR	DATE	APPROVED			
				0		Hu.Jiang	09.10.2019	HC.Qiu			

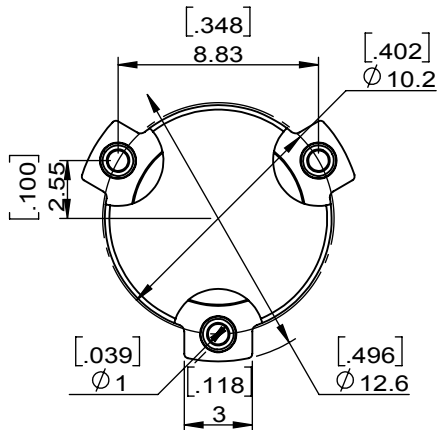

SPECIFICATIONS	
Part's Number	JCM3300T3600PT8RC
Frequency(GHz)	3.300~3.600
Direction	CCW
Insertion Loss(dB)MAX	0.25@+25°C 0.3@-40~+100°C
Isolation(dB)MIN	23.0@+25°C 21.0@-40~+85°C 20.0@+85~+100°C
Return Loss(dB)MIN	23.0@+25°C 21.0@-40~+85°C 20.0@+85~+100°C
3rd IMD(dBc)MAX	-65@2x10W tones, Spacing 5MHz-
Power FWD/REV/PK(Watt)	80/80/200
Operating Temperature(°C)	-40~+100
Storage Temperature(°C)	-55~+125
2nd/3rd Harmonic(dBc)	20/10
Port impedance	real : 50±4 (Ω) imaginary : 0±7.5 (Ω)
Additional Notes	

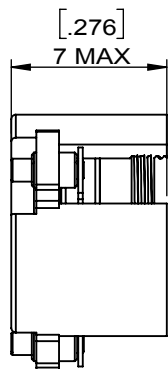
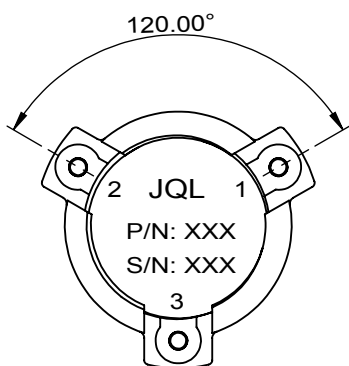
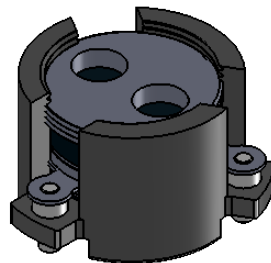
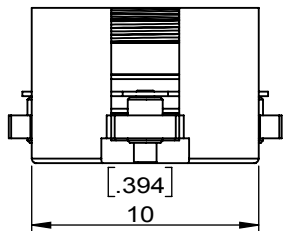
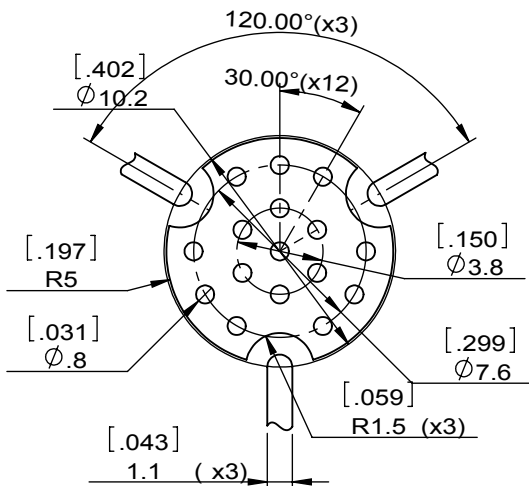

Copper Pattern

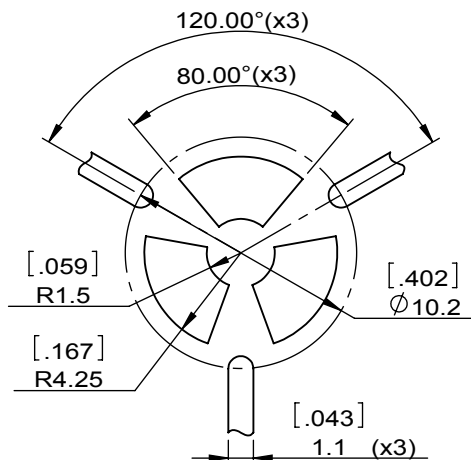

Soldermask Pattern



This document is the property of JQL Electronic Inc. It cannot be copied, duplicated, used for manufacturing purposes or communicated to third party as a whole or partly, without the written consent of JQL Electronic Inc.

JQL JQL Electronic Inc				
MATERIAL: STEEL		DWG NO: JCM3300T3600PT8RC		
SURFACE TREATMENT: SILVER PLATING		DWG BY:	Hu.Jiang	09.10.2019
DESCRIPTION: SMT CIRCULATOR		CHK'D BY:		SCALE
		APPV'D BY:		3:1
Unit: mm[inch]		Tolerance: Liner: ±0.25 Anguar: ±0.5°	The First:	A4